

# DK50/100 installation cautions

## Mounting/fixing position

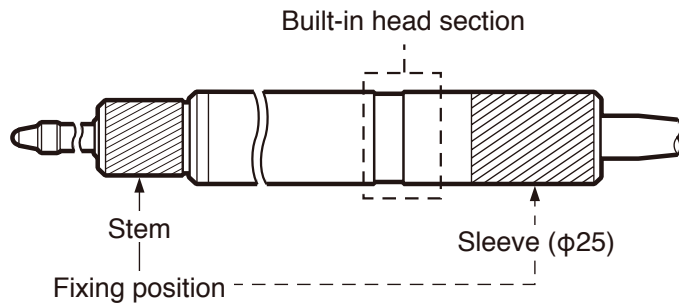

## Mounting holder configuration dimensions (for reference)

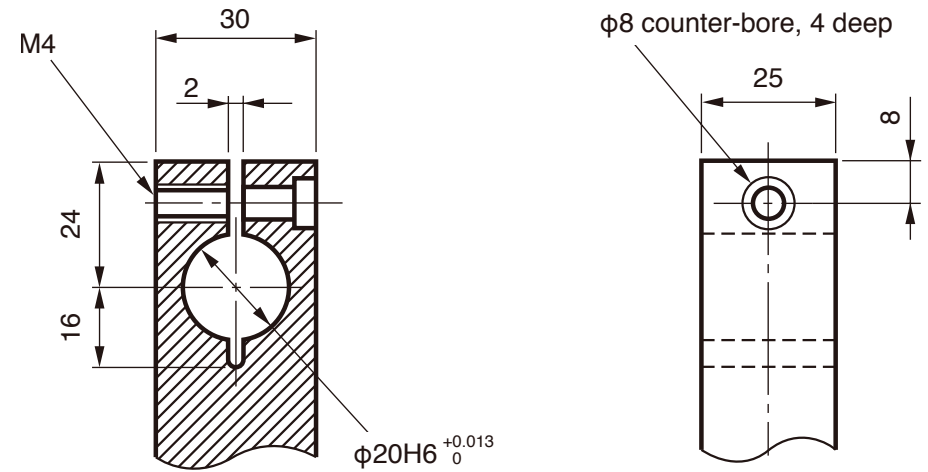

Tightening torque: 4 N·m  
Hex. socket head bolt M4 is used.

Unit: mm