

Magnescale®

Counter Unit

LY71

Read all the instructions in the manual carefully before use and strictly follow them.
Keep the manual for future references.

Instruction Manual (Operating manual)

Contents

1. Basic Operation	1-1
1-1. Enabling Display	1-1
1-2. Setting the Display Value to Zero (Reset Function)	1-1
1-3. Changing the Display Resolution	1-1
1-4. Reading the Maximum/Minimum Values of Measured Data	1-2
1-5. Recalculating the Maximum and Minimum Values (Restart Function)	1-2
1-6. Switching the Display Data (Example: Maximum value → Peak-to-peak Value)	1-3
1-7. Setting Values to the Display (Preset Function)	1-3
2. Applied Operation	2-1
2-1. Inch/mm Selector	2-1
2-2. Determining the Measurement Datum Point Position (Datum Point Setting)	2-1
2-3. Switching between the ABS Display and INC Display	2-2
2-4. Relocating the Datum Point Position (Reference Point Operation)	2-2
2-4-1. Recording the datum point position	2-2
2-4-2. Relocation of the datum point position	2-3
2-5. Pausing Maximum Value/Minimum Value Calculation (Pause)	2-3
2-6. Pausing Updates of Display Data (Latch)	2-4
2-7. Changing the Display Scale	2-4
2-8. Reducing Flickering of the Minimum Digit	2-4
2-9. Disabling Key Operation (Preventing Accidental Operation)	2-4
2-10. Power Outage Detection On/Off	2-5
2-11. Power Save	2-5
2-12. Using Measuring Units with Two Axes for Measurement	2-5
2-13. Operation for each Axis	2-6
2-14. Changing the Display Axis	2-6
2-15. Master Calibration	2-7
2-16. External Input/Output	2-8
2-16-1. Outputting a signal when going past the zero point	2-8
2-16-2. Resetting with an external signal	2-8
2-16-3. Switching the display data from an external device	2-8
2-16-4. Sending alarm signals to an external device	2-8
2-16-5. Sending the display mode to an external device	2-9
2-16-6. Relocating the datum point position with an external signal	2-9
2-16-7. Sending the reference point detected signal to an external device	2-9
2-16-8. Operating the hold function from an external device	2-9
2-16-9. Operating restart from an external device	2-10
2-16-10. Setting a value input by Preset from an external device	2-10
2-17. Clearing the Error Display	2-10
2-18. Presetting Multiple Points	2-10
2-19. Compensating the Position	2-11
2-19-1. Compensation	2-11
2-19-2. Linear Compensation	2-11
2-20. Outputting Data to BCD	2-14
2-21. Using the Comparator	2-14



1. Basic Operation

The operations below are possible after performing “4. Settings” in the Installation Manual. Perform all the operations in the order below, and be sure that you understand the basic operation. After understanding the basic operation (“4-2. Making and Changing the Basic Settings” in the Installation Manual), make any necessary basic settings before using the unit.

1-1. Enabling Display

When the basic settings are made (“4. Settings” in the Installation Manual), the data for one axis of the measuring unit is displayed.

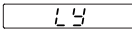
1 Perform the procedure in “4-1. Enabling Operation” in the Installation Manual.

2 Press the  key on counter display A.
..... The counter display changes from the *L Y* display  →  (Count display)

3 Move the measuring unit.
..... The numerical value of the displayed position data changes. 

* If no value is displayed, and an *Error* display is shown, go to “2-17. Clearing the *Error* Display”.

1-2. Setting the Display Value to Zero (Reset Function)

This sets the displayed value to zero.

1 Press the  key.  → 

* The display value can also be reset by an external signal (Reference: “2-16-2. Resetting with an external signal”)

* Counter display C is a reference display, and so it cannot be reset.

1-3. Changing the Display Resolution

After making the basic settings, the display resolution is the same as the input resolution of the measuring unit. To use a lower display resolution, follow the procedure below to change the display resolution.

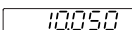
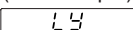
1 Press the  key during count display.  → *Por DSP* →  (For example)

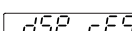
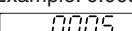
2 Press the  key.
..... The display resolution is shown.  →  (Example: 0.005)

3 Press the  key. (The ABS lamp flashes.)

4 The display changes each time the  key is pressed. Press until the desired display resolution is shown.

5 Press the  key.
..... The resolution displayed in step 4 is set.

1-4. Reading the Maximum/Minimum Values of Measured Data

1 Press the $\text{\textcircled{R}}$ key on counter display A.
 This clears the display data for all counter displays to zero.

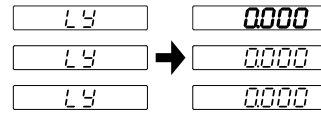

2 Move the measuring unit in the positive or negative direction to start measurement.

3 The data is updated after measurement is completed.
 Counter display B: The maximum value for the distance moved in step **2** is displayed. (The MAX lamp lights on.)

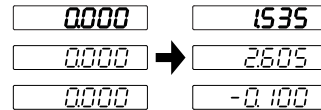

..... Counter display C: The minimum value for the distance moved in step **2** is displayed. (The MIN lamp lights on.)



Read and confirm the display data.

1-5. Recalculating the Maximum and Minimum Values (Restart Function)

Pressing the $\text{\textcircled{S}}$ key recalculates the maximum and minimum values from that point.

1 Press the $\text{\textcircled{S}}$ key.

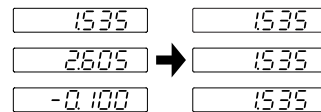

2 Move the measuring unit.
 The maximum and minimum values are recalculated, and the display data is updated.

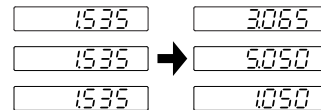

- * Recalculation is also possible by pressing the $\text{\textcircled{R}}$ key instead of the $\text{\textcircled{S}}$ key. However, in this case, all recalculation starts from zero. (See “1-4. Reading the Maximum/Minimum Values of Measured Data”.)
- * Recalculation is also possible using the preset operation. (See “1-7. Setting Values to the Display (Preset Function).”)
- * Restart is also possible with an external signal. (See “2-16-9. Operating restart from an external device”.)

1-6. Switching the Display Data (Example: Maximum value → Peak-to-peak Value)

Currently-displayed data can be switched.

1 Press the  key on counter display B. (The ABS lamp flashes.)

2 Press the  key twice.

3 Press the  key. (The ABS lamp lights off or on.)
 The value shown on counter display B changes to the peak-to-peak value.

..... Peak-to-peak value =
 MAX (maximum value) – MIN (minimum value)

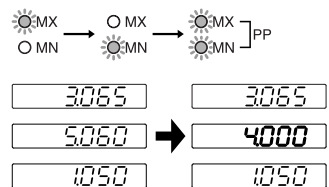



Read and confirm the display data.

- * Display data can be switched by an external signal. (See “2-16-3. Switching the display data from an external device”.)
- * This procedure does not allow switching of the displayed axis. (For details about switching the axis, see “4-3. Advanced Settings” in the Installation Manual.)

1-7. Setting Values to the Display (Preset Function)

This sets a value to the current value that is displayed.

1 Press the  key. (The  lamp lights on.)

2 Press the  key on counter display A. (The ABS lamp flashes.)

3 Use the  key to move the digit, and then use the numeric keys to enter the value.

4 Press the  key.
 This sets the entered value. At the same time, the restart function is activated, and the maximum and minimum values are also set to the same value. (The peak-to-peak value becomes 0.)

- * An entered value can be set from an external device using the preset operation. (See “2-16-10. Setting a value input by Preset from an external device”.)
- * Counter display C is a reference display, and so it cannot be preset.

This completes the basic operations.

The next sections describe other operations and functions. Be sure to make the necessary settings in the basic and advanced settings before using. (See “4. Settings” in the Installation Manual.)

2. Applied Operation

Note

When the \odot key is pressed to switch to axis selection mode, pressing a different function key cancels axis selection mode.

2-1. Inch/mm Selector

Basically, this operation can be done in any mode.

* The selector is only effective if the destination country is set to US or STD. You can confirm the current unit by looking at the lit display below the key.

1 Press the \odot key.

2 Returning to the previous unit display

Press the \odot key again.

2-2. Determining the Measurement Datum Point Position (Datum Point Setting)

Although pitch measurement (Incremental (INC)) can be made from positions that were reset or preset, the total dimensions are unknown. The total measurement (Absolute (ABS)) can also be made when the datum point is set.

(See “2-3. Switching between the ABS Display and INC Display”.)

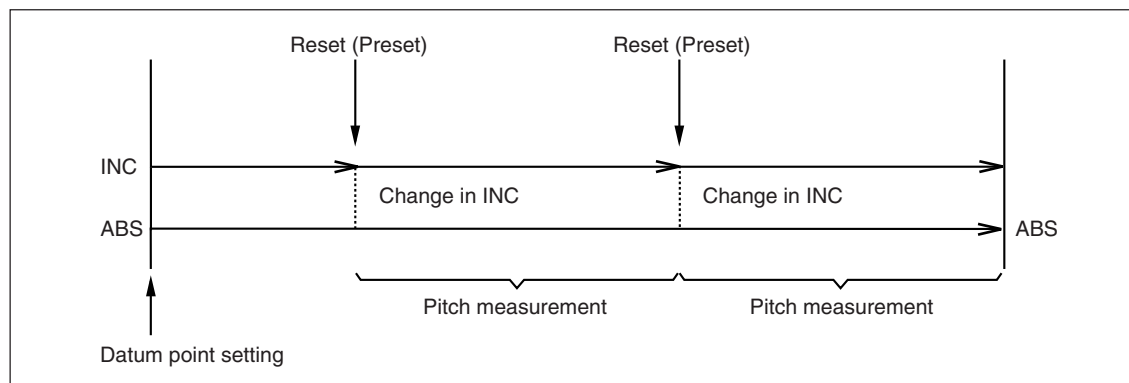

Note

- The maximum value, minimum value, and peak-to-peak value are calculated based on the INC value.
- The counter display showing the peak value (maximum value, minimum value, peak-to-peak value) cannot set the datum point.

1 Press the \odot key. (The \odot lamp lights on.)

2 Press the \odot key. (The ABS lamp flashes.)

3 Use the \odot key to move the counter display digit, and then use the numeric keys to enter the position (numerical value) for the datum point.

4 Use the \odot key to set the value.

* When the datum point is set, the INC value is initialized and is identical to the ABS value until it is reset or preset.

* Counter display C is a reference display, and so it cannot set the datum point.

2-3. Switching between the ABS Display and INC Display

Switching between the ABS display and INC display enables measurement while checking the total dimensions and pitch.

The display can be switched when the P lamp, S lamp, or REF lamp is not lit on. When the ABS display is shown, the ABS lamp on the counter display lights on.

Note

When the P lamp is lit on, the setting is fixed at INC display. When the S lamp/ REF lamp is lit on, the setting is fixed at ABS display. However, a counter display that shows the peak value (maximum value, minimum value, peak-to-peak value) is fixed at INC display and cannot be switched to ABS display. (See “2-2. Determining the Measurement Datum Point Position (Datum Point Setting)”.)

1 Press the ABS/INS key.

2 **Returning to the previous display**

Press the ABS/INS key again.

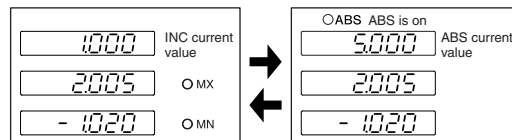

2-4. Relocating the Datum Point Position (Reference Point Operation)

When using a measuring unit with reference point, performing the reference point operation beforehand (see procedure below) enables relocation of the datum point position even if the datum point position that was set is unknown.

Note

When Addition axis is selected, operation on reference point is not available.

When the datum point position is unknown (examples)

- After the power is turned off, the measuring unit is moved
- Staring of the current value (See “4-3. Advanced Settings” (Current value store) in the Installation Manual.)
- The power was cut off during operation

2-4-1. Recording the datum point position

1 Press the REF key. (The REF lamp lights on.)

2 Press the ABS key. (The ABS lamp flashes.)

3 Press the ENT key.

4 Move the measuring unit until it beeps. (The beeping sound is made when going past the reference point.)
..... The display is held.

5 Press the ABS key.

6 Press the ENT key.
..... The hold on the display is canceled.

This enables storing and relocation of the distance between the datum point position and reference point.

2-4-2. Relocation of the datum point position

7 When the REF lamp is not lit on

Press the  key. (The  lamp lights on.)

8 Press the  key. (The ABS lamp flashes.)

9 Press the  key.
..... The stored value is displayed.

10 Press the  key.

11 Move the measuring unit until it beeps. (The beeping sound is made when going past the reference point.)
..... The count is started, and the datum point position is relocated.

* The datum point position can be relocated by input from an external signal. (See “2-16-6. Relocating the datum point position with an external signal”.)



* Counter display C is a reference display, and so it cannot perform reference point operation.

2-5. Pausing Maximum Value/Minimum Value Calculation (Pause)

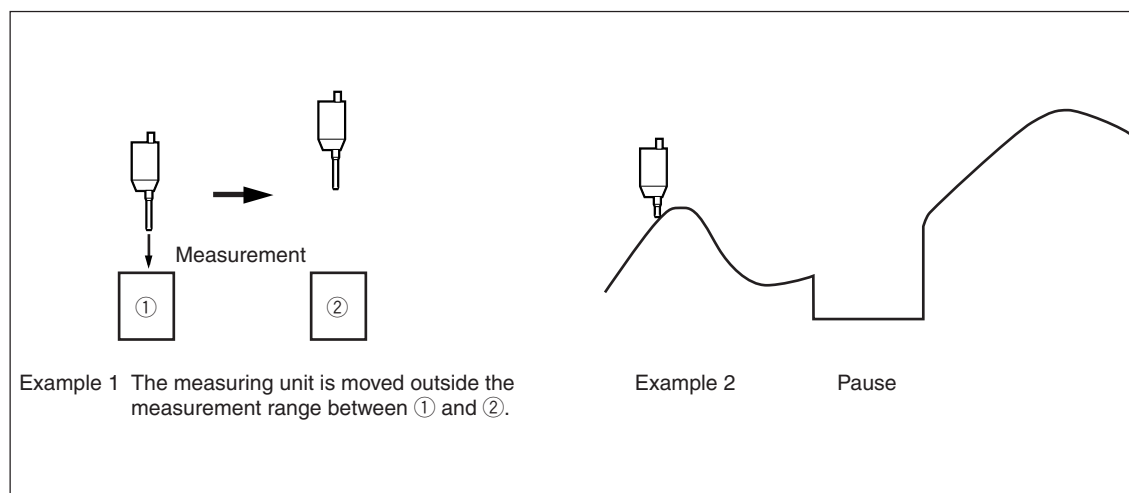
When making continuous measurements of multiple objects to calculate the total maximum value and minimum value, in some cases, the measurements will be updated to unneeded data unless they are stopped before finishing. In these types of cases, perform the procedure below to temporarily stop calculation of the maximum value and minimum value.



1 Select *PAUSE* in the Hold setting.
➔ Installation manual “4-3. Advanced Settings” (Hold function)



2 Press the  key. (The  lamp lights on.)
..... The calculation of the maximum and minimum values is paused.

Restarting

Press the  key. (The  lamp lights off.)

2-6. Pausing Updates of Display Data (Latch)

If you prefer to read selected position data without pausing the calculation itself, updating of the display only can be paused.

- 1 Select $L\ H\ T\ H$ in the Hold setting.
➔ Installation manual “4-3. Advanced Settings” (Hold function)
- 2 Press the  key.
..... Updating of the display data is paused. (The  lamp lights on.)

Restarting

Press the  key. (The  lamp lights off.)

* Pause can be performed by input from an external signal.

2-7. Changing the Display Scale

This sets the count display magnification. This is effective for situations such as when measuring an object where the scale was changed.

➔ Installation manual “4-3. Advanced Settings” (Scaling)

2-8. Reducing Flickering of the Minimum Digit

If the number for the minimum digit of the display value is unstable and difficult to check, flickering of the display can be reduced.

➔ Installation manual “4-3. Advanced Settings” (Flicker control)

2-9. Disabling Key Operation (Preventing Accidental Operation)

This locks key operation to prevent unintended operations.

➔ Installation manual “4-3. Advanced Settings” (Key lock)

After making the setting, the only valid key operations are the  (Standby) key and  key.

A password must be entered to remove the key lock. Pressing the  key displays the password input display.

➔ Installation manual “4-3-9. Key Lock”

2-10. Power Outage Detection On/Off

In the shipping settings, $\text{L} \text{ } \text{H}$ is displayed to indicate that a power outage has occurred. When the detection setting is activated, $\text{L} \text{ } \text{H}$ is displayed whenever the power is turned on.

The setting can also be made to display the count directly when the power is turned on without detection.

Note

The basic settings cannot be made during count display. To change the basic settings, first return the display to the setting (power outage detection on).

➔ Installation manual “4-3. Advanced Settings” (Display at power ON)

2-11. Power Save

The display can be turned off automatically when no operations will be performed for a certain period of time such as when pausing work during operation. The display is restored whenever the measuring unit is moved or a key operation is made.

➔ Installation manual “4-3. Advanced Settings” (Sleep)

2-12. Using Measuring Units with Two Axes for Measurement

The count for a measuring units with two axes can be displayed individually or the sum/difference of the two axes can be displayed. This enables measurement of the difference, thickness, or other parameters.

➔ Installation manual “4-2. Making and Changing Basic Settings” (Input Axis Selection)

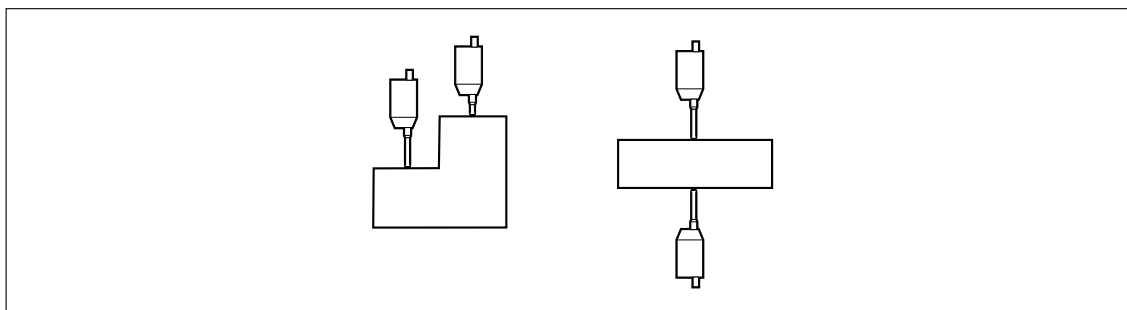

If the data for two axes are displayed individually, the maximum value and minimum value of the two axes can also be measured.

➔ “2-13. Operation for each Axis”

2-13. Operation for each Axis

When using a measuring units with two axes, the following operations can be performed for each axis.

- Restart
- Hold
- Switching of display data
- ABS/INC display switching

These settings are made after pressing the  key on the counter display of the axis to be set.

Note

To make the settings for all axes, do not press the  key before making the settings.

Example 1



1 Press the  key on counter display A.



2 Press the  key.
..... This performs switching for counter display A only.

3 Press the  key.
..... The setting is saved.

Reference

Counter display B  key →  key : B only is restarted. ^(Note)

Counter display A  key →  key : Hold function is enabled for A only. ^(Note)

Counter display B  key →  key: B only is switched to Absolute value display.

(Note)

The axis displaying the same measuring unit data also operates simultaneously with the axis.

Example:

Counter display A: Maximum value of 1st axis

Counter display B: Minimum value of 1st axis

2-14. Changing the Display Axis

This can display the 1st axis input on counter display B and the 2nd axis input on counter display A.

➔ Installation manual “4-3. Advanced Settings” (Display axis, and display data at power ON)

2-15. Master Calibration

When using a gauge-type measuring unit, an operation known as master calibration is sometimes performed when starting operation. The master calibration operation can be simplified if a gauge-type measuring unit with reference point is used together with the master calibration function in this counter unit.

Note

If the master calibration function is set to ON, addition operation is not available.

Master calibration value setting

- 1** Set the master calibration to ON.
→ Installation manual “4-2. Making and Changing Basic Settings”
- 2** Press the $\overset{\text{RESET}}{\bigcirc}$ key in the $\text{L} \text{H}$ display mode.
..... This sets to the reference point signal standby mode.
- 3** Go past the reference point.
..... The count display is shown.
- 4** Press the S key.
- 5** After installing the master for performing master calibration, bring the gauge-type measuring unit into contact with the master.
- 6** Press the $\overleftarrow{\bigcirc}$ key.
- 7** Use the numeric keys to enter the master calibration value.
- 8** Press the $\overset{\text{ENT}}{\bigcirc}$ key.
..... The master calibration value is saved.

After this is completed, the master calibration operation is no longer necessary.

Relocating the master calibration value

- 1** Turn on the power, and press the $\overset{\text{RESET}}{\bigcirc}$ key in the $\text{L} \text{H}$ display mode.
..... This sets to the reference point signal standby mode.
- 2** Go past the reference point.
..... The master calibration value is relocated.

After this is completed, the master calibration operation is no longer necessary.

- * Relocation of the master calibration value can also be performed by input from an external signal. (An external reference point load input signal is input.)

2-16. External Input/Output

2-16-1. Outputting a signal when going past the zero point

When going past zero in incremental value mode, the signal results are output.

Outputs 1, 2 : Counter display A output signal

Outputs 3, 4 : Counter display B output signal

* Counter display C is a reference display, and so output saving is not possible.

➔ Installation manual “4-3. Advanced Settings” (General-purpose output)

2-16-2. Resetting with an external signal

Connections are required.

Ex. RESET A: A-axis reset

Ex. RESET B: B-axis reset

➔ Installation manual “4-3. Advanced Settings” (General-purpose input)

2-16-3. Switching the display data from an external device

Connections are required.

Ex. IN A: Input signal for counter display A

Ex. IN B: Input signal for counter display B

Ex. IN C: Input signal for counter display C

➔ Installation manual “4-3. Advanced Settings” (General-purpose input)

2-16-4. Sending alarm signals to an external device

Connections are required.

OUT A1, OUT A2 : Counter display A output

OUT B1, OUT B2 : Counter display B output

* Counter display C is a reference display, and so output saving is not possible.

➔ Installation manual “4-3. Advanced Settings” (General-purpose output)

2-16-5. Sending the display mode to an external device

Connections are required.

* Counter display C is a reference display, and so output saving is not possible.

➔ Installation manual “4-3. Advanced Settings” (General-purpose input)

2-16-6. Relocating the datum point position with an external signal

The operation in “2-4-2. Relocation of the datum point position” can be used to relocate with an external signal.

Connections are required.

Ex. IN A: Input signal for counter display A

Ex. IN B: Input signal for counter display B

Ex. IN C: Not available

➔ Installation manual “4-3. Advanced Settings” (General-purpose input)

2-16-7. Sending the reference point detected signal to an external device

When performing the reference point operation, the reference point detected signal can be sent. The signal is not output even when going past the reference point unless the reference point operation is performed.

Connections are required.

OUT A1, OUT A2 : Counter display A output

OUT B1, OUT B2 : Counter display B output

* Counter display C is a reference display, and so output saving is not possible.

➔ Installation manual “4-3. Advanced Settings” (General-purpose output)

2-16-8. Operating the hold function from an external device

The hold function (Latch, Pause) can be performed by an external signal. This function is activated when turned ON/OFF once, and it is disabled when turned ON/OFF again.

Connections are required.

Ex. IN A: Input signal for counter display A

Ex. IN B: Input signal for counter display B

Ex. IN C: Input signal for counter display C

➔ Installation manual “4-3. Advanced Settings” (General-purpose input)

2-16-9. Operating restart from an external device

Restart can be performed by an external signal.

Connections are required.

Ex. IN A: Input signal for counter display A

Ex. IN B: Input signal for counter display B

Ex. IN C: Input signal for counter display C

➔ Installation manual “4-3. Advanced Settings” (General-purpose input)

2-16-10. Setting a value input by Preset from an external device

This sets a value input by Preset from an external device. However, the value that is called is the first (No. 1) of the three values.

Connections are required.

2-17. Clearing the *ERROR* Display





When an *ERROR* display is shown, pressing the  key clears the display. However, the error cannot be cleared if the cause of the error is not removed.

Differences from regular reset

In addition to the incremental value, the absolute value is also reset to zero. Therefore, to relocate the datum point position, perform the procedure in “2-4-2. Relocation of the datum point position”. If the master calibration function is set to ON, master relocation is performed, and the measuring unit must go past the reference point.

2-18. Presetting Multiple Points

Up to three preset values can be saved.

- 1** Press the  key. (The  lamp lights on.)
- 2** Press the  key.
- 3** Press the  key to switch to the preset number to be set.
- 4** Enter a numerical value.
- 5** Press the  key.
..... This sets the entered value.

Repeat steps **2** to **5**.

2-19. Compensating the Position

If the machine or other object where the measuring unit is mounted has some sagging and the position is shifted, a compensation can be entered. Use the procedure below to measure the compensation value. Use the linear compensation in the Installation Manual to set the compensation amount that is obtained.

2-19-1. Compensation

Generally a machine tool has its inherent geometric error. For example, with a knee type milling machine, the knee is slightly tilted as the table moves and the horizontal component of this inclination is added to the measuring unit displacement as an error. When the displayed value is obtained by adding an error compensation corresponding to the actual displacement, the mechanical error is compensated for and a more accurate display value is obtained for the actual displacement of the machine table, thus yielding more accurate machining.

The unit is factory-set so that the compensation function is not activated.

If the compensation value is not known, set the compensation value to OFF in the “advanced settings”, and redo the settings after measuring the compensation value.

2-19-2. Linear Compensation

The linear compensation is set using the following process.

Measure the compensation (error) value → Set the linear compensation value (“Advanced Settings”)

Compensation amount : up to $\pm 600 \mu\text{m}/\text{m}$ (can be entered in measuring unit input resolution units)

* Max. $\pm 1000 \mu\text{m}/\text{m}$ with the expansion function

The compensation amount is a displacement of 1 m for the millimeter operation. Input the value as millimeter unit.

Error (compensation) measurement (Linear compensation)

Following is an example of machine error measuring procedures for determining the amount of compensation.

- 1 Place a block gauge (A) on the machine table until the block gauge (A) assumes the same temperature as the machine table.
Then touch the surface B of the block gauge (A) with a block gauge (B).

Example: $L = 250 \text{ mm}$ ($L = 9.84250 \text{ in}$)

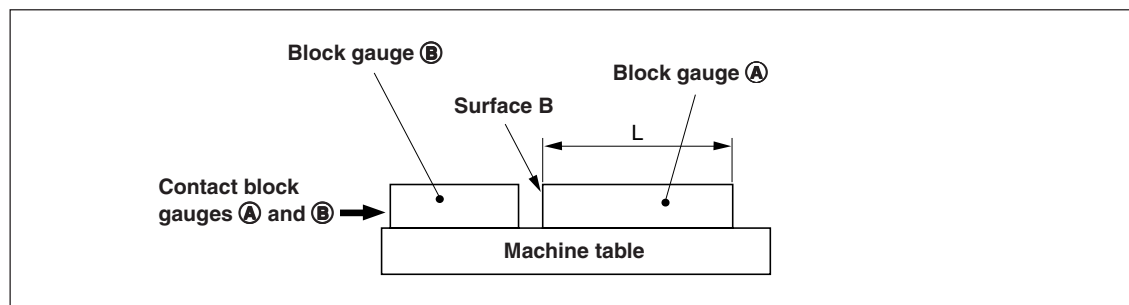

- 2** Touch the surface A of the block gauge (A) with the probe of an electric micrometer or dial gauge and align the micrometer hand to read “0.” Simultaneously reset the counter unit.



When the display resolution is 0.001 mm

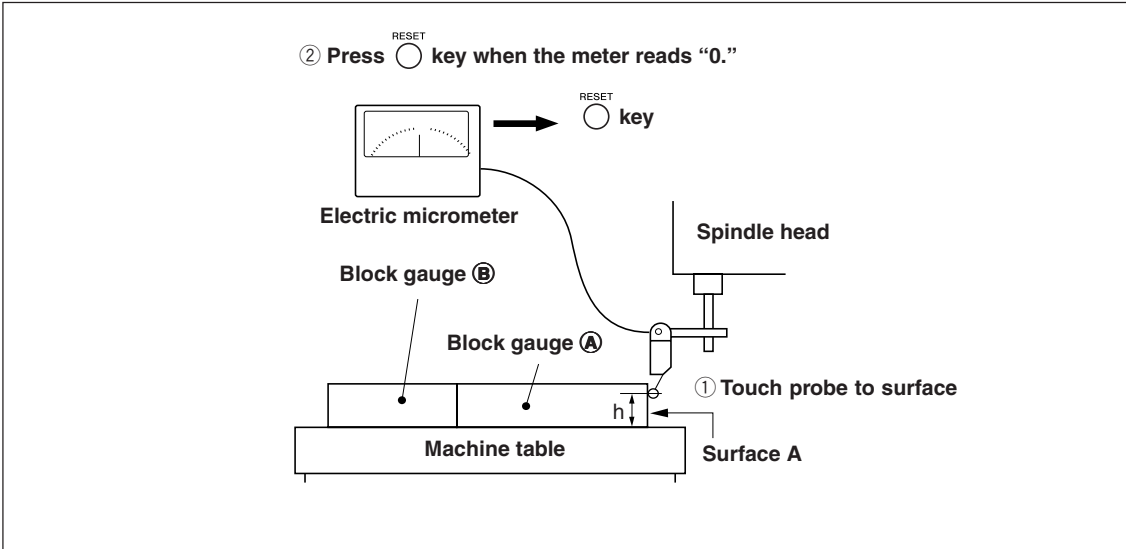

- 3** Next, move the table away from the probe and remove the block gauge (A), move the machine table again, touch the surface C of the block gauge (B) with the probe of the electric micrometer or dial gauge, and move the machine table until the meter reads “0.” Be sure to make a note of the difference between the displayed value on the counter unit and the length of the block gauge (A), because this is the linear error to be compensated.

An example of setting the amount of linear compensation is shown below.



Make a note of linear error to be compensated for.

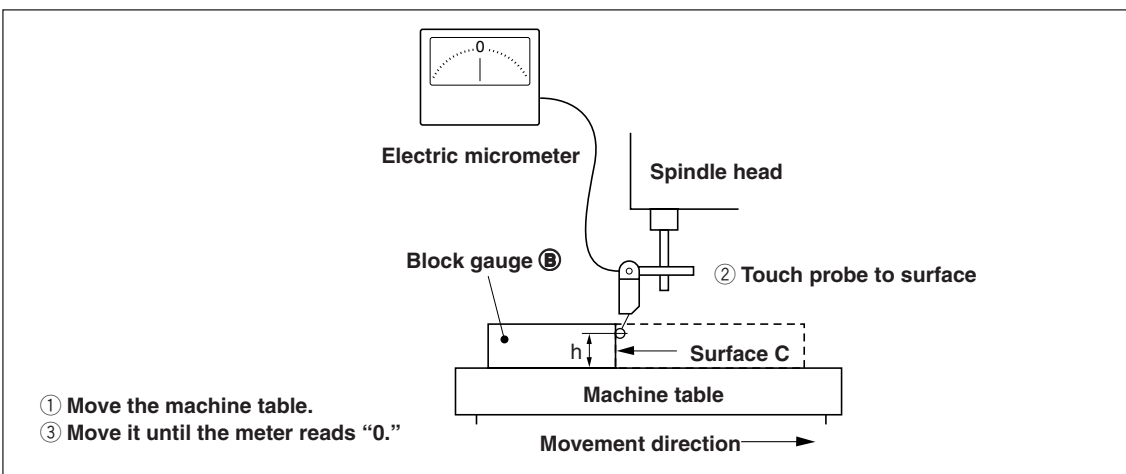

Note: Do not change the probe height h until finished measuring.

Examples of setting amount of linear compensation (Linear compensation)

After the mechanical error is measured, calculate and set the compensation amount as shown in the following examples.

Addition to or subtraction from displayed value for displacement

L : Length of block gauge (A)

\varnothing : Displayed value for the distance between surfaces A and C

When $L > \varnothing$, add a compensation amount to the displayed value.

Set an appropriate positive compensation amount.

Example : If L = 250 mm and $\varnothing = 249.996$ mm

If L is converted to 1m ($L \times 4$), $\varnothing \times 4 = 999.984$, so the compensation amount is 0.016 mm.

When $L < \varnothing$, subtract a compensation amount from the displayed value.

Set an appropriate negative compensation amount.

Example : If L = 250 mm and $\varnothing = 250.004$ mm

If L is converted to 1m ($L \times 4$), $\varnothing \times 4 = 1000.016$, so the compensation amount is -0.016 mm.

2-20. Outputting Data to BCD

When using the BCD unit (LZ71-B) (sold separately), three types of data can be output per unit. Up to two BCD units can be used.

When using one unit

Three types of data can be output by switching to DRQ1, 2, or 3.

Example:

DRQ1 : 1st axis maximum value

DRQ2 : 2nd axis minimum value

DRQ3 : Current value of 1st + 2nd axis

When using two units

1st axis : Limited to 1st axis data

(The data that can be output are the 1st axis current value, maximum value, minimum value, and peak-to-peak value.)

2nd axis: Limited to 2nd axis data

(The data that can be output are the 2nd axis current value, maximum value, minimum value, and peak-to-peak value.)

- The logic for the output data can be set as either positive or negative logic.
- The output format of the data can be selected from three types. (See the BCD Unit (LZ71-B) Instruction Manual)

For details about the BCD output connection and operation timing, see the BCD Unit (LZ71-B) Instruction Manual.

2-21. Using the Comparator

When using the comparator unit (LZ71-KR) (sold separately), the preset values and magnitude relationship are compared, and the display of the judgment result and retrieval of the output signal are possible. Only one comparator unit can be used.

Comparison objects

1st axis data (current value, maximum value, minimum value, peak-to-peak value), or 1st and 2nd axis addition data

Selection of the comparison object data

This is selected in the advanced settings.

The judgment results can be held by latch input.

The judgment results are retrieved by signal.

The judgment results can be output by relay signals and open collector signals.

Only one judgment result location is turned on for the relay signals and open collector signals.

For details, see the Comparator Unit (LZ71-KR) Instruction Manual.

このマニュアルに記載されている事柄の著作権は当社にあり、説明内容は機器購入者の使用を目的としています。したがって、当社の許可なしに無断で複写したり、説明内容(操作、保守など)と異なる目的で本マニュアルを使用することを禁止します。

本手册所记载的内容的版权归属Magnescale Co., Ltd., 仅供购买本手册中所记载设备的购买者使用。

除操作或维护本手册中所记载设备的用途以外, 未经 Magnescale Co., Ltd. 的明确书面许可, 严禁复制或使
用本手册的任何内容。

The material contained in this manual consists of information that is the property of Magnescale Co., Ltd. and is intended solely for use by the purchasers of the equipment described in this manual. Magnescale Co., Ltd. expressly prohibits the duplication of any portion of this manual or the use thereof for any purpose other than the operation or maintenance of the equipment described in this manual without the express written permission of Magnescale Co., Ltd.

Le matériel contenu dans ce manuel consiste en informations qui sont la propriété de Magnescale Co., Ltd. et sont destinées exclusivement à l'usage des acquéreurs de l'équipement décrit dans ce manuel.

Magnescale Co., Ltd. interdit formellement la copie de quelque partie que ce soit de ce manuel ou son emploi pour tout autre but que des opérations ou entretiens de l'équipement à moins d'une permission écrite de Magnescale Co., Ltd.

Die in dieser Anleitung enthaltenen Informationen sind Eigentum von Magnescale Co., Ltd. und sind ausschließlich für den Gebrauch durch den Käufer der in dieser Anleitung beschriebenen Ausrüstung bestimmt.

Magnescale Co., Ltd. untersagt ausdrücklich die Vervielfältigung jeglicher Teile dieser Anleitung oder den Gebrauch derselben für irgendeinen anderen Zweck als die Bedienung oder Wartung der in dieser Anleitung beschriebenen Ausrüstung ohne ausdrückliche schriftliche Erlaubnis von Magnescale Co., Ltd.

Magnescale Co., Ltd.

Shinagawa Intercity Tower A-18F, 2-15-1, Konan, Minato-ku, Tokyo 108-6018, Japan